

# 8. ENERGY STORAGE SYSTEMS

## 8.1. Introduction

This chapter attempts to shed some light on energy storage systems with stationary and building applications. Among these, we must highlight the batteries, from the oldest ones which were employed for these purposes, to those of lead-acid (Reddy & Linden, 2010), or those that harbour a very promising future, the redox flow batteries, RFB (Rajarithnam & Vassallo, 2016; Zhang & Zhang, 2015); finally, we cannot forget the lithium-ion batteries, widely used today (Julien et al., 2016).

Human beings need to store energy to make it available when necessary. The release of this energy can occur in the same form in which it was stored, or in a different manner. There are different methods or systems to store energy: electrical, mechanical, biological, electrochemical... So, for example, capacitors and superconductors are examples of electrical storage systems, while hydraulic pumping or flywheel, are mechanic systems. Regarding biological storage systems, the combustion of matter such as biomass, agricultural waste, oil, natural gas or coal should be mentioned. In these cases, the energy stored in the bonds of the molecules that participate as reagents in the chemical reaction is released under heat form. The reason for this favourable energy release is the energetic difference between the energy of the bonds in reactants (organic matter and oxygen in combustion) and those of the products (water and carbon dioxide). As it happened with the electrochemical systems, the batteries need to be mentioned, including different modalities: conventional batteries, flow batteries, fuel cells.

### 8.1.1. What is a battery?

A battery is an energy storage system that releases the energy, which is chemically stored, in the form of electricity through a chemical process called redox, that is to say, a chemical reaction of reduction-oxidation. The batteries can be composed of one or more cells. Each cell includes a cathode (positive pole), an anode (negative pole) and an electrolyte (ionic conductor). Batteries accumulate energy during the charging process, which is later released in the discharge process. Depending on the

reversibility of the charge and discharge processes, there are primary batteries (not rechargeable) and secondary batteries (rechargeable).

The phenomenon responsible for the charge is a certain chemical reaction (which will vary depending on the materials that constitute the cathode and anode. Consequently, the type and subtype of the battery can be classified). The inverse chemical reaction is the responsible for the phenomenon of discharge.

The chemical reaction of the battery during the charge process is shown below:

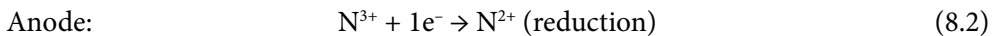
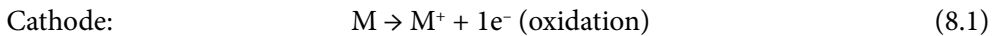

Thus, in the chemical reaction represented, in the charging process, an oxidation semi-reaction would take place at the cathode (the M species loses an electron and becomes positively charged, increasing its oxidation state by +1), while in the anode the semi-reaction reduction takes place (the  $\text{N}^{3+}$  species loses an electron, decreasing its oxidation state from +3 to +2). In this case, energy (electrical) is used to store it (in chemical form). In the relevant discharge reaction, inverse processes would occur, releasing energy in the form of electricity.

The chemical reaction of the battery during the discharge process (inverse of the charge reaction) is shown below:

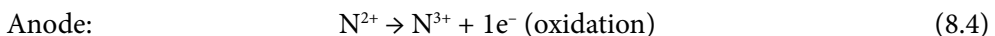

As it has been described, the materials that constitute cathode and anode determine the chemical reaction that takes place in the battery. In turn, some parameters of the battery such as the voltage are determined by this: the specific capacity (amount of electricity stored / released per unit mass, expressed in  $\text{Ah}\cdot\text{kg}^{-1}$ ), the specific energy (voltage x specific capacity, measured in  $\text{Wh}\cdot\text{kg}^{-1}$ ) or the specific power (voltage x current, measured in  $\text{W}\cdot\text{kg}^{-1}$ ). Other parameters of the battery are the cycle life (number of battery cycles), cycle efficiency (quotient between the discharge and charge energy), the charge/discharge speed (time required to obtain the full theoretical capacity), the state of charge (SOC, percentage of battery charged), the depth of discharge (DOC, percentage of discharge that can be reached in a battery) among others. It must be considered that certain parameters such as the actual capacity of the battery, average life... can also be affected by different factors such as the design of the battery, the amount of active material, the particle size of the materials that constitute cathode and anode or the presence of additives, among others.

## 8.2. The acid-lead battery

### 8.2.1. Brief history, constitution, operation and other aspects

The lead-acid battery is the oldest example of a rechargeable battery. It was invented by the French physicist Gastón Planté in 1859. Today, it is still widely used in automotive, forklift, and large uninterruptible power source (UPS) systems, although other systems can also be used for this application, such as the flywheel or the supercapacitor.

In the mid-70s of the previous century, one of the main drawbacks of this type of batteries was alleviated: maintenance. The liquid electrolyte was transformed into wet separators and the envelope was sealed. In addition, safety valves were added to allow gas ventilation during the charge and discharge processes. Two types of sealed batteries emerged: SLA (sealed lead acid), known as Gelcell (used in vehicles) and VRLA (valve-regulated lead-acid; Fig. 8.1).

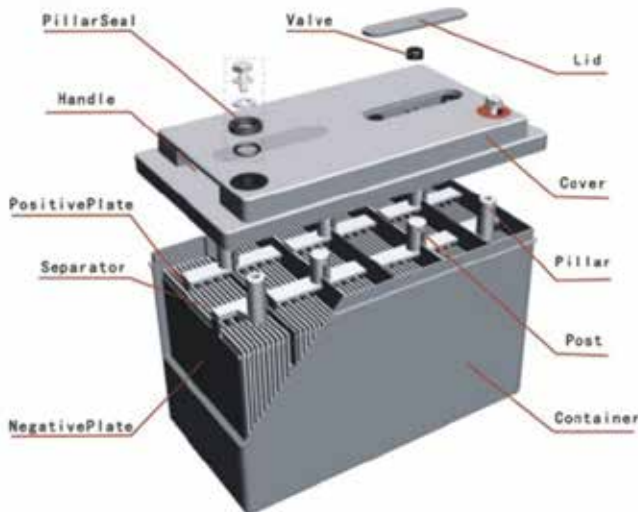

Fig. 8.1. Scheme of a VRLA battery (Source: WEB-1)

The lead-acid battery consists of two plates (Fig. 8.2), positive and negative, and an electrolyte ( $\text{H}_2\text{SO}_4$  dil.). It should be noted that prior to the assembly of the battery, the lead plates that will act as electrodes must undergo a series of processes for their activation, such as the formation of the paste or curing. Thus, initially high purity

Pb plates are used, which are oxidized to PbO. Subsequently, the plates are treated separately, since certain additives must be added to the negative plate.

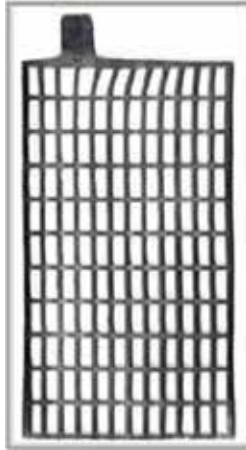
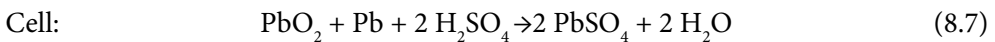
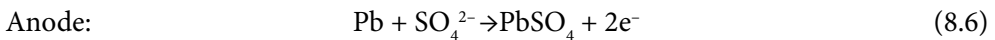
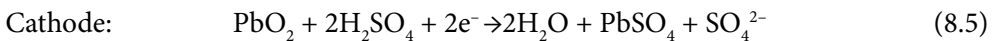

Fig. 8.2. Lead grid image (Source: Caballero, 2007)

To obtain the electrochemically active material, a paste is formed by mixing the PbO with water/H<sub>2</sub>SO<sub>4</sub>, to subsequently subject the material to the curing step, which consists in heating the electrodes under controlled humidity. Finally, the lead oxide together with the sulphates of the cured paste is electrochemically transformed into active material, PbO<sub>2</sub> (cathode) and metallic Pb (anode).

The chemical reaction in the discharge process occurs as described below:



Charged battery

Discharged battery

This type of batteries offers a maximum voltage of 2.1 V, yielding a specific energy of 33-42 Wh·kg<sup>-1</sup> and a specific power of 180 W·kg<sup>-1</sup>. Regarding the charge/discharge speed, the discharge capacity diminishes greatly as this parameter increases, as can be seen in the Fig. 8.3. The voltage of the cell also decreases slightly.

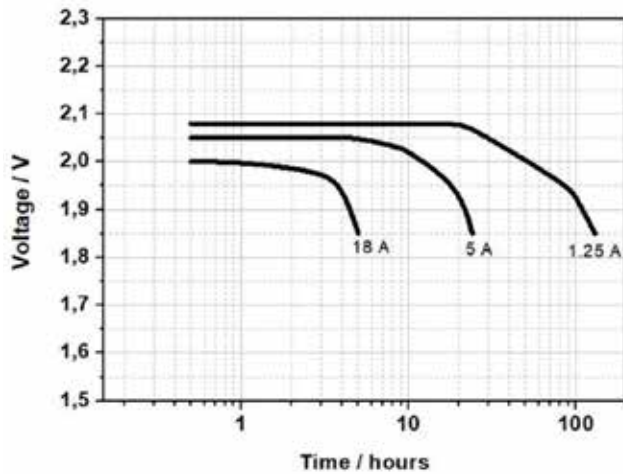

Fig. 8.3. Time of discharge depending of the discharge rate (Source: own elaboration)

In addition, in terms of stationary applications, these batteries can also be used to store electrical energy because of the transformation of renewable energies such as solar or wind. Its applications as starter batteries are also well known. However, due to their low energy density, they are not suitable to be used in portable devices. The main advantages and disadvantages of these batteries can be seen in Table 8.1.

Table 8.1. Main advantages and disadvantages of the lead-acid battery (Source: own elaboration)

Advantages	Disadvantages
Simple and inexpensive manufacturing	Low energy density
Well known and widely studied technology	It cannot be stored in discharged state; the potential should not be lesser than 2.10 V
Low self-discharge, perhaps the lowest of all rechargeable batteries	It only allows a limited number of cycles with full discharge
Requires little or no maintenance	Environmentally dangerous; it must be recycled properly
Able to generate high discharge currents	Overheating problems when charging improperly

### 8.2.2. Applications of lead-acid batteries: use in UPS

As mentioned above, one of the applications of lead acid batteries is as a central element of UPS. In this specific case, the ones usually used are those of the VRLA type. They are manufactured with a range of capacities ranging from 30 Ah to several Ah. UPSs are used to protect electrical equipment from possible power cuts, providing

power only a few milliseconds after the cutting takes place. It is possible to find them in repeaters of mobile telephony, cable distribution centres, Internet servers, airports, hospitals, banks and even military installations as an auxiliary supplier of electric current. They can provide power as 200 VA to momentarily power a personal computer, several kW to provide electricity in a home for a few hours or even, or about 50 MW of electrical storage to power cities, as in Fairbanks, Alaska.

As shown in Fig. 8.4, the use of these systems involves the usage of rectifiers and current inverters, since the battery must be charged with direct current.

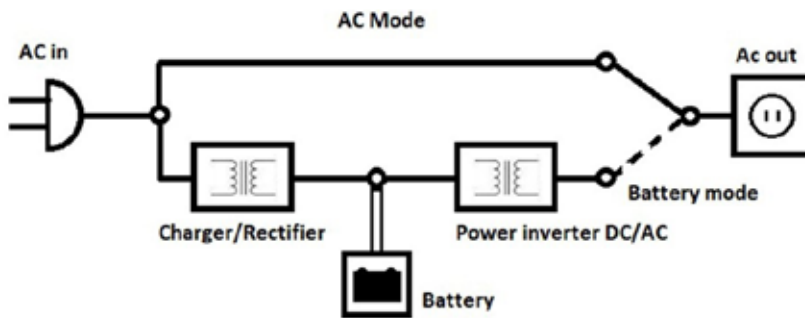

Fig. 8.4. UPS configuration. When a power cut occurs, the battery provides electricity (Source: own elaboration)

Batteries are the essential element in UPS systems of this type (Fig. 8.5). They are essential, and at the same time, critical, given that, if a single cell of the system fails, it can involve the loss of the charge, incurring downtime.

About the conditions of the lead-acid battery in the UPS, it is critical that the temperature remains around 25 °C. Although these batteries can withstand extreme temperature ranges (−40°C-50°C), it is a fact that in extreme conditions both life and performance are clearly affected. In fact, it can be taken as a reference that for every increase of +10°C the life of the battery is reduced by half.

Another important aspect of its use is, regardless of the charge/discharge speed, that the batteries must be charged at 10% of the nominal capacity. In any case, it is not recommended to charge them below 5% or above 20%.

Regarding safety, the following precautions should be considered:

- Do not install batteries of this type in closed rooms, due to the emission of gases.
- No smoking in the immediate vicinity.
- In the case of liquid electrolyte, transfer them correctly (SLA batteries), and in case of spillage, cleanse with abundant water, never use soap and go to the doctor if necessary.

- Recycle them correctly.



Fig. 8.5. UPS image (Source: WEB-2)

## 8.3. The lithium ion battery

### 8.3.1. Brief history, constitution, operation and other aspects

In 1991, Sony Corporation commercialized the first Li ion battery. These batteries are widely used today in many applications, thanks to their interesting properties: high energy density, reduced weight, reduced environmental impact, ease of recycling, safety, low maintenance. The Table 8.2 shows the advantages and limitations of this type of batteries.

Table 8.2. Main advantages and disadvantages of the Li ion battery (Source: own elaboration)

Advantages	Disadvantages
High energy density ( $200 \text{ Wh}\cdot\text{kg}^{-1}$ ) and high voltage	Expensive manufacturing
Relatively low self-discharge	They can age even when they are not being used
Hardly requires maintenance, or even null	They need protection circuit
No memory effect (they do not lose capacity when charging without having previously discharged completely)	Moderate discharge current
High life	

As it was observed in the table, one of the great advantages of this battery is the high potential that it supplies by single cell, consequence of the high voltage in which the charge discharge reaction takes place. The following reaction can illustrate a charging process that occurs inside a cell of this type (the discharge reaction would be the reverse).

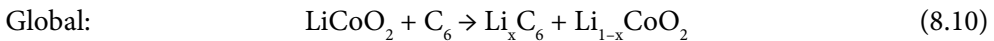
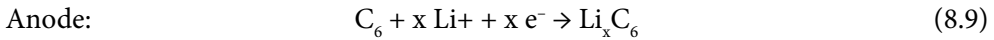
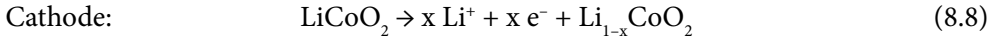

As it is normal in batteries, a redox reaction takes place, in which during the charging process there is a process of oxidation in the cathode, and one of reduction in the anode (the inverse processes will occur in the discharge). Concomitantly with these redox processes, de-intercalations and intercalations of Li ions are produced at anode and cathode, respectively. This is the case in basic cathode materials such as  $\text{LiCoO}_2$ ,  $\text{LiMn}_2\text{O}_4$  or  $\text{LiFePO}_4$ . They are briefly described below.

### 8.3.1.1. $\text{LiCoO}_2$

It is a cobalt lithium oxide with layer structure (Fig. 8.6), although with this same structure other oxides can be found using different transition metals (V, Cr, Fe, Ni or Mn). It is also possible to find isostructural materials with more than one different transition metal, such as  $\text{LiNi}_{0.5}\text{Co}_{0.5}\text{O}_2$  or  $\text{LiNi}_{0.5}\text{Co}_{0.2}\text{Mn}_{0.3}\text{O}_2$ . The latter, also known as NMC is widely used today for its good properties.

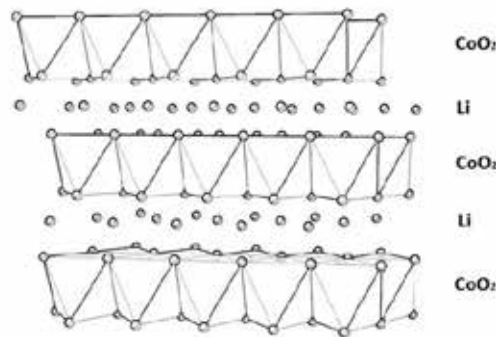

Fig. 8.6.  $\text{LiCoO}_2$  layer structure (Source: partially modified from WEB-3)

The structure of these materials is  $\alpha$ - $\text{NaFeO}_2$ -type and can be described as a compact cubic packing of oxygen atoms in which lithium atoms and transition metal atoms



occupy the octahedral positions, so that sheets of  $\text{MO}_2$  are formed consisting of octahedrons  $[\text{MO}_6]$  that share edges. Between these sheets are located the lithium atoms with octahedral coordination  $[\text{LiO}_6]$ . As cathode material has an important attraction, since it has a high potential in open circuit (OCV), 3.9-4.7 V, also providing a high specific energy:  $1070 \text{ Wh}\cdot\text{kg}^{-1}$  (at 3.9 V). However, this type of material has some limitations such as low life (compared to other materials such as  $\text{LiFePO}_4$ ) and not being able to operate at high temperatures.

### 8.3.1.2. $\text{LiMn}_2\text{O}_4$

It is a spinel type oxide (Fig. 8.7). As it has a three-dimensional crystal structure, these materials have some advantages over layer ones, such as preventing the intercalation of other secondary species (such as electrolyte solvent molecules) or less expansion-contraction of the crystalline structure, which should theoretically translate into a greater structural stability. Its structure can be described as a cubic packing in which the oxygen atoms occupy positions 32e of the spatial group  $\text{Fd}3\text{m}$ . The manganese cations are in the middle of the octahedral holes (16d), while the lithium ions occupy the tetrahedral positions (8a). In this structure a series of empty voids are interconnected, so that 3-D corridors are formed, facilitating the diffusion of lithium ions. The electrochemical process involves the reversible disinsertion of Li ions, at a potential close to 4.0 V vs  $\text{Li}^+/\text{Li}$ . The capacity that can be obtained with this material is  $147 \text{ mAh}\cdot\text{g}^{-1}$  and presents an adequate reversibility and cyclability. However, the cells assembled with this material undergo a slight drop in capacity due to the instability of the electrolyte. In turn, this affects the dissolution of the material in the electrolyte, accompanied by the Jahn-Teller effect, which implies a distortion of the structure. This problem can be partially solved by doping (replacing) part of the Mn with other metals such as Mg, Zn, Ni... The introduction of these secondary actors leads in some cases to an expansion of the potential window of the cells to the 5.0 V region, that would result in a greater energy contribution. However, this becomes inconvenient since at these values it is difficult to control the stability of the electrolyte.

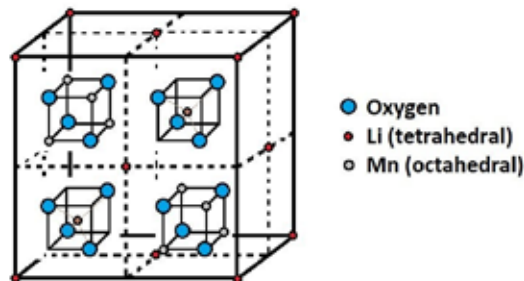

Fig. 8.7.  $\text{LiMn}_2\text{O}_4$  spinel structure (Source: own elaboration)

### 8.3.1.3. LiFePO<sub>4</sub>

It is a compound of olivine type structure, with a spatial group of Pnma symmetry (Fig. 8.8). The structure consists of an octahedral of FeO<sub>6</sub> shared in the corner and LiO<sub>6</sub> shared in the edge parallel to axis b, which are linked together by the tetrahedral PO<sub>4</sub>. Inside, one-dimensional cavities are formed where lithium ions can diffuse. This compound is relatively inexpensive, non-toxic and friendly to the environment. The potential of the reversible electrochemical insertion / disinsertion process of lithium is 3-3.5 V vs Li<sup>+</sup>/Li. It can release a theoretical capacity of 170 mAh·g<sup>-1</sup> and is very stable during the cycling. Its main drawback is its low conductivity, so the addition of conductive additives such as coal is necessary. Due to its properties and characteristics, it is one of the most common Li-ion commercial cathode materials available today.

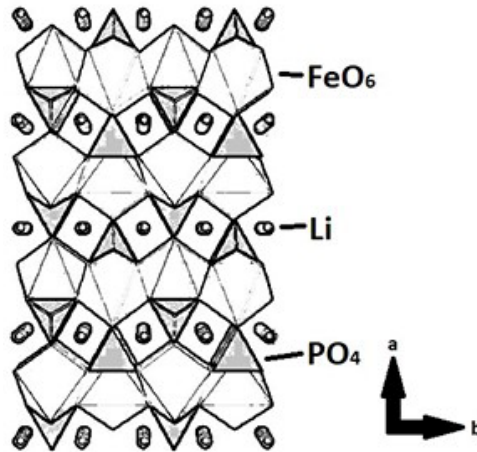

Fig. 8.8. LiFePO<sub>4</sub> olivine structure (Source: partially modified from Tarascon & Armand, 2001)

Finally, the advantages and disadvantages of these three types of cathode materials can be compared in the Table 8.3.

Table 8.3. Comparison of Li ion battery cathodes (Source: own elaboration)

Material	Advantages	Disadvantages
LiCo <sub>2</sub> (pioneer material)	High specific capacity High voltage	Expensive Not very environmentally-friendly Low charge and discharge ratios It cannot operate at high temperatures

Material	Advantages	Disadvantages
$\text{LiMn}_2\text{O}_4$	High voltage Environmentally-friendly It can operate at high temperatures	Lower specific capacity Shorter life cycle
$\text{LiFePO}_4$ (one of the most marketed today)	Not expensive Greater security Greater life It can operate at high temperatures	Lower voltage Intermediate specific capacity (vs $\text{LiCoO}_2$ & $\text{LiMn}_2\text{O}_4$ )

### 8.3.1.4. Anodic materials and electrolytes

As far as anodic materials are concerned, lithium due to its low weight, high electrochemical potential and high volumetric energy density would be the desirable material. However, the high reactivity of lithium is a serious safety problem. In addition, it presents the problem of dendritic growth with successive charges and discharges. All this made necessary to search for alternatives, and although the study of structures such as oxides, chalcogenides and transition metal nitrides, lithium metal alloys and even titanium spinels has been addressed, it is carbon, specifically graphite (see structure in Fig. 8.9), the most used anodic material. It is safe, has a great structural stability in the processes of insertion / disinsertion of lithium, a low discharge potential (0.1 vs  $\text{Li}^+/\text{Li}$ ), and a high specific capacity ( $372 \text{ mAh}\cdot\text{g}^{-1}$ ). However, graphite presents certain drawbacks: in the first charge it consumes an amount of electricity much higher than the theoretical, recovering only 80-90% in the first discharge. The excess charge is attributed to the formation of a layer called solid electrolyte interface (SEI).

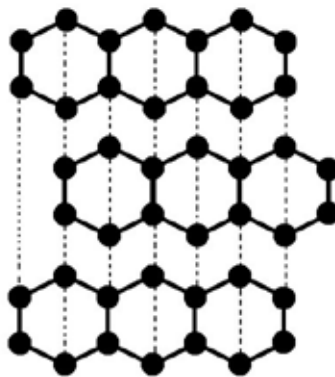

Fig. 8.9. Graphite structure (Source: own elaboration)

Finally, about the third component of the battery, as electrolyte, a lithium ionic salt, such as  $\text{LiPF}_6$ ,  $\text{LiBF}_4$  or  $\text{LiClO}_4$ , is used, stable against oxidation and very good conductor. They must be dissolved in an organic solvent such as ethylene carbonate (EC), dimethyl carbonate (DMC), diethyl carbonate (DEC), ethyl methyl carbonate (EMC), propylene carbonate (PC)... or in mixtures of these. Another possibility that provides greater security, flexibility and greater ease of processing would be the use of solid polymeric electrolytes, such as polyethylene oxide or polyacrylonitrile.

### 8.3.2. Stationary applications in homes and residential areas

Lithium-ion batteries are widely used today. Its low weight and good power density make them very convenient for portable devices such as laptops, mobile phones, power tools, and, even, for hybrid or electric vehicles. On the other hand, they are also interesting for stationary applications. For this purpose, so-called second-life lithium-ion batteries are increasingly used (without losing the perspective that other systems such as NaS are also widely used in these applications). But what are second-life batteries? In demanding applications such as electric vehicles, the lithium ion batteries used must cover certain values of cyclability, capacity, energy density, capacity to withstand charges or discharges at fast speeds... With prolonged and intense use for years, the batteries reduce their capacity. When it is at 80%, they are no longer suitable for use in the automotive industry. Then, they can be given a second life, allocating them to less stressful applications, such as stationary applications. Obviously, being less efficient batteries, a larger number (compared to the use of completely new batteries) of them becomes necessary, something that can be perfectly assumed if it is considered that this type of applications does not involve moving or transporting these batteries.

As specific and interesting examples of residential applications for lithium ion batteries, community storage systems such as “PureWave Community Energy Storage System” (WEB-4) or storage systems for homes such as “Powerwall” or “Powerwall 2” (WEB-5) can be described.

Regarding the PureWave Community Energy Storage System, it is a community storage system that can restore the electric flow in a matter of seconds. It provides an energy of 25-75 kWh. On the other hand, the Powerwall (see scheme in Fig. 8.10) and Powerwall 2 systems are designed to complement solar panels in houses, so they can be charged during the day, and provide electricity at night. As specified by Tesla (WEB-5), the Powerwall system provides a power of 3.3 kW, with batteries that operate in a wide temperature range ( $-20$ - $50^\circ\text{C}$ ) and an energy of 6.4 kWh. In the case of Powerwall 2 the power increases up to 5 kW (with peaks of 7 kW) and the energy is 13.5 kWh. Up to 9 systems can be attached.



Fig. 8.10. Scheme of Powerwall Tesla battery combined with a StorEdge solar panel (Source: WEB-6)

## 8.4. Redox flow batteries

Redox flow batteries are a type of electrochemical cell in which cathodic and anodic active materials are dissolved in a liquid, within the system, which are generally separated by a membrane. The liquid in the cathode tank is called catholyte, while that in the anodic tank is the anolyte. These electrolytes are continuously flowing, driven by pumps, and the electrolyte fraction that passes through the electrode undergoes an oxidation-reduction reaction at each moment. The nature of this electrochemical reaction depends on the subtype of the flow system in question, or what is the same, of the species present in anolyte and catholyte. Fig. 8.11 outlines a generic redox flow battery.

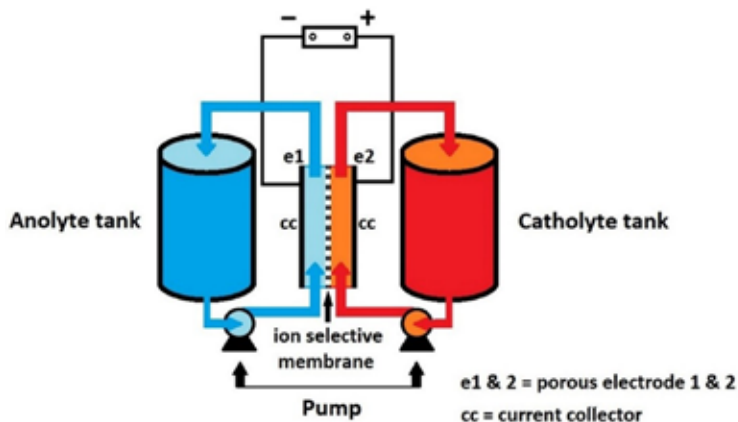

Fig. 8.11. Scheme of a redox flow battery (Source: own elaboration)

It is an easily scalable system: as it is a type of battery in which the active matter is dissolved in the electrolyte, the energy density is variable and depends on its concentration. Thus, playing with the concentration of catholyte and anolyte and with the size of the tanks, we can have energy values from a few kWh to 10 MWh. In the behaviour of this type of batteries, the crossing of species through the separator is a key factor. As a result, adequate membrane characteristics and permeability are essential. Another factor to consider is the transportation of mass and charge in the electrolyte.

On the other hand, the voltage supplied by each single cell will obviously depend on the species present in the electrolytes. In fact, it is the way in which these systems can be sub-classified: Fe/Cr, all vanadium, Zn/Br<sub>2</sub>, all iron... By connecting several cells in series (generally in a bipolar way) the total voltage of the system can be increased. Regarding the power supplied by these systems, this is related to the design and size of the electrodes.

### 8.4.1. Fe/Cr system

This system was the pioneer among the flow batteries, developed in the 70s of the previous century by NASA. The cathode is a mixture of Fe (II) and Fe (III) ions, while at the anode there are Cr (II) and Cr (III) ions. The electrolyte is HCl.

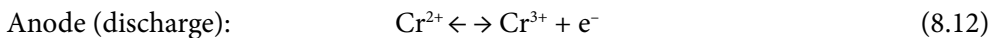
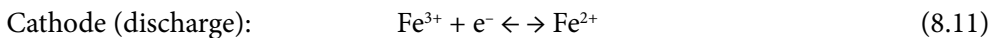

The potential of this system is 1.2 V (0.77 V Fe(III)/Fe(II); -0.74 V Cr(III)/Cr(II)). As for the limitations of this system, one of the main ones is the slower kinetics of chromium. For this reason, an electrocatalyst is required.

### 8.4.2. All vanadium system

It is an interesting system due to the amount of different oxidation states that vanadium can have (+2, +3, +4, +5). The negative electrode contains V (II) and V (III), while the positive contains VO<sup>2+</sup> and VO<sub>2</sub><sup>+</sup>. This system has an interesting advantage: catholyte and anolyte contain the same species dissolved, so the transfer of vanadium from one side of the membrane to the other does not imply the contamination of the corresponding electrolyte, although there is a certain loss of efficiency. In any case, since there is a different pH in catholyte and anolyte, the transferred forms can be regenerated.

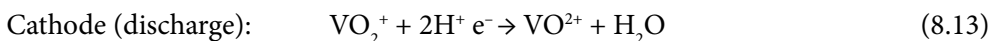

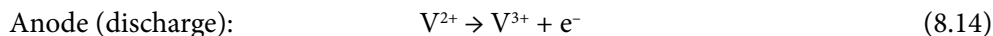

The potential of this system is 1.3 V ( $1.00 \text{ V VO}_2^+/\text{VO}^{2+}$ ;  $-0.26 \text{ V V}^{3+}/\text{V}^{2+}$ ). Among the flow systems, the all vanadium system is one of the most interesting and used, and with great potential for stationary applications, specifically for storage of renewable energy. The main problems are related to the solubility of vanadium in the electrolyte and a low energy/volume ratio.

### 8.4.3. Zn/Br<sub>2</sub> system

It is a system that provides a voltage of 1.8 V, high energy densities and high durability. The Zn/Br<sub>2</sub> system contains ZnBr<sub>2</sub> dissolved in water in both electrolytes. In addition, it is usual to add other salts such as ZnCl<sub>2</sub>, NaCl or KCl to improve the conductivity and / or stability. In the positive electrode the reaction that takes place is the oxidation-reduction of Br<sub>2</sub>/2Br<sup>-</sup> (1.1 V). Bromine (Br<sub>2</sub>) is a toxic and corrosive species. For this reason, complexing agents must be used to reduce their effect. Complexing agents such as N-ethyl, N-methyl morpholinium, N-ethyl-N-methylpyrrolidinium (Fig. 8.12), N-chloromethyl-N-methylpyrrolidinium bromide, or N-methoxymethyl-N-methylpiperidinium, among others. The salts of bromide complexes are usually referred as “Quats” (QBr) or as the polybromide phase.

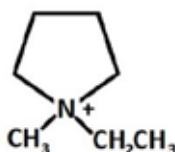
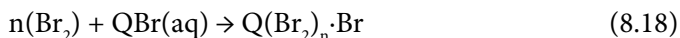
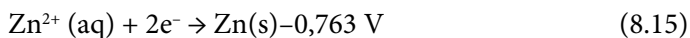

Fig. 8.12. N-ethyl-Nmethylpyrrolidinium (Source: own elaboration)

About the anode, the reaction that takes place is the oxidation-reduction of zinc ( $\text{Zn}^{2+} + 2\text{e}^- \leftrightarrow \text{Zn}$ ;  $-0.76 \text{ V}$ ). Consequently, the reaction that occurs in this cell is shown below:



The reduction of zinc ion involves the deposition of solid metallic zinc on the electrode (zinc plating), thus comparing it, and increasing the energy density.

However, excessive growth of zinc could lead to the perforation of the membrane and the consequent short circuit.

In this type of system, research is still required for its optimization: it is a key aspect that the membrane prevents the transit of species, since it would lead to the consequent recombination to zinc bromide; control over bromine complexation on the one hand, and dendritic growth, on the other, are also essential for the proper development of this technology.

#### 8.4.4. Applications of flow batteries. Are they the best positioned for stationary applications for the future?

The complex design of the flow batteries and the fact that they are not exactly light make their use unfeasible for portable type applications or electric vehicles. However, they can be, if they are not already, a commitment to the future in stationary applications of energy storage. A flow battery developed and optimized, as in the case of all vanadium system, can reach 20 years of life without its capacity being affected over time, and providing a 100% depth of discharge in all cycles. In addition, these batteries have other interesting advantages such as not being flammable or explosive. The high availability of vanadium on Earth is another factor that makes these batteries interesting. Companies like StorEn (WEB-7) are an example of commitment to this technology. Others like the British RedT (WEB-8) can also make us see that the future of batteries with stationary applications of energy storage is in the flow batteries, having installed in the farm of Olde House, United Kingdom, a system to store the excess of solar energy (it could allow the reduction of demand to the electricity network of up to 50%). The system, specifically based on vanadium, has a storage capacity of 1 MWh, a maximum power of 90 kW and a life of 25 years.

## References

- Caballero, A. (2007) *Síntesis y caracterización de materiales nanométricos para su aplicación en baterías recargables de ion-litio y plomo-ácido*. Doctoral Thesis. University of Cordoba.
- Julien, C., Mauger, A., Vijh, A. & Zaghbi, K. (2016) *Lithium batteries. Science and Technology*. Springer.



Rajarithnam, G. P. & Vassallo, A. M. (2016) *The Zinc/Bromine Flow Battery. Materials Challenges and Practical Solutions for Technology Advancement*. SpringerBriefs in Energy. Springer.

Reddy, T. (ed.) & Linden, D. (2010) *Linden's handbook of batteries*. McGraw-Hill Education.

Tarascon, J. M. & Armand, M. (2001) Issues and challenges facing rechargeable lithium batteries. *Nature*, 414, 359-367.

WEB-1: Website of Company UPS Battery Center [Online]. Available from: <http://www.upsbatterycenter.com/blog/valve-regulated-lead-acid-vrla-batteries/> [Accessed 25<sup>th</sup> August 2018].

WEB-2: Website of Company Electronic Environments Co. LLC. [Online]. Available from: <https://blog.eecnet.com/eecnetcom/bid/35069/maintaining-extending-the-life-of-your-data-center-s-ups-batteries> [Accessed 25<sup>th</sup> August 2018].

WEB-3: Image from WIKIPEDIA [Online]. Available from [https://en.wikipedia.org/wiki/Lithium\\_cobalt\\_oxide#/media/File:Lithium-cobalt-oxide-3D-polyhedra.png](https://en.wikipedia.org/wiki/Lithium_cobalt_oxide#/media/File:Lithium-cobalt-oxide-3D-polyhedra.png). [Accessed 25<sup>th</sup> August 2018].

WEB-4: S&C Electric Company (2018) *S&C Electric Company. Excellence Through Innovation*. [Online] Available from: <https://www.sandc.com/> [Accessed 10<sup>th</sup> August 2018].

WEB-5: Tesla (2018) *Tesla*. [Online] Available from: <https://www.tesla.com/powerwall> [Accessed 10<sup>th</sup> August 2018].

WEB-6: Website of Energy Storage News [Online]. Available from <https://www.energy-storage.news/news/solaredge-customers-to-get-tesla-powerwall-batteries-within-six-months> [Accessed 25<sup>th</sup> August 2018].

WEB-7: StorEn Technologies (2018) *StorEn Technologies. Energy you can depend on*. [Online] Available from <http://www.storen.tech/> [Accessed 10<sup>th</sup> August 2018].

WEB-8: RedT energy plc (2018) *RedT energy storage*. [Online] Available from: <http://www.redtenergy.com/> [Accessed 10<sup>th</sup> August 2018].

Zhang, Z. & Zhang, S. S. (2015) *Rechargeable Batteries. Materials, Technology and New Trends*. Green Energy and Technology. Springer.